

3-1. B プッシュロッドとプロペラシャフト Pushrod and Propeller Shaft

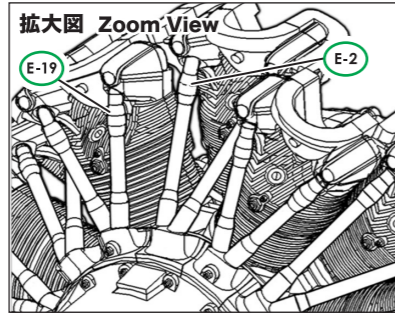
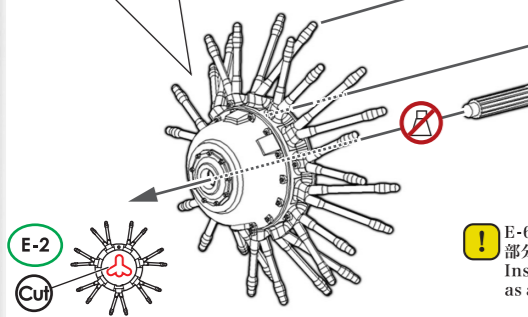
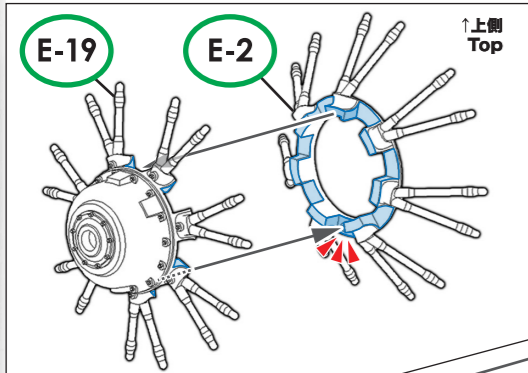

実機におけるパーツ名
Name of the parts implemented in the actual aircraft.

- E-19 ギアハウジング / Gear Housing
- E-2 プッシュロッド / Pushrod
- E-6 プロペラシャフト / Propeller Shaft

各パーツ接着位置
Parts configuration after assembly.

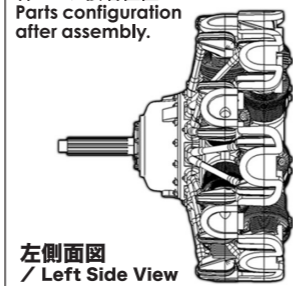

左側面図 / Left Side View

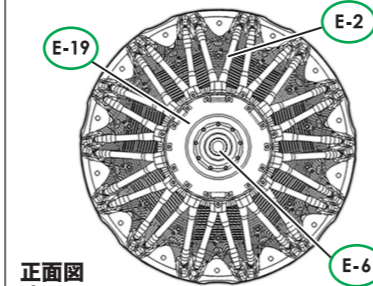

正面図 / Front View

3-1. C エンジンコンプレッサ Engine Compressor

実機におけるパーツ名
Name of the parts implemented in the actual aircraft.
E-11 エンジンコンプレッサ / Engine Compressor

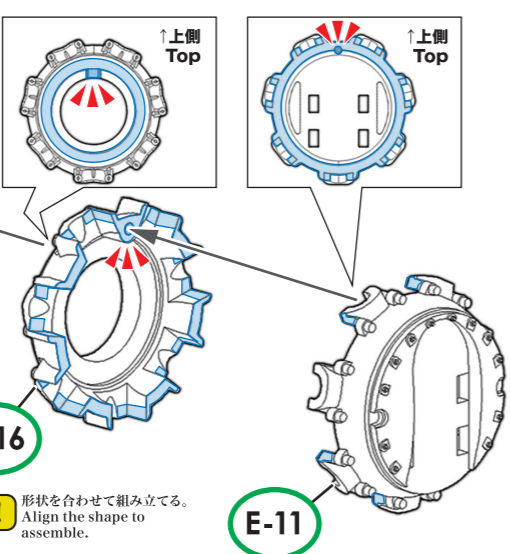
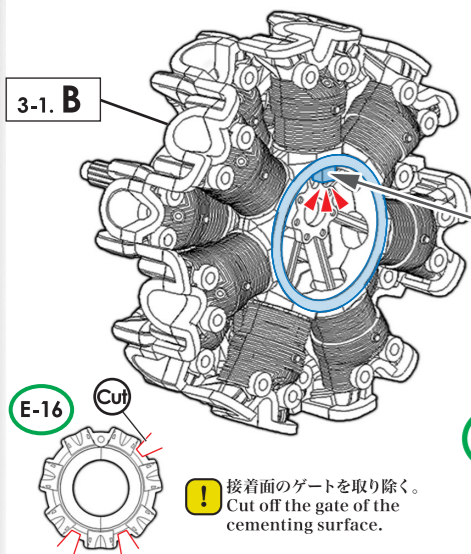

各パーツ接着位置
Parts configuration after assembly.

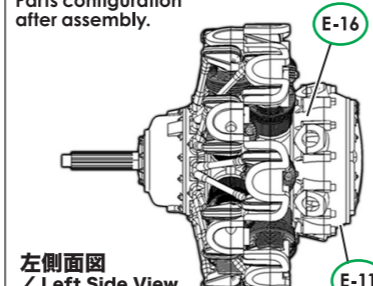

左側面図 / Left Side View

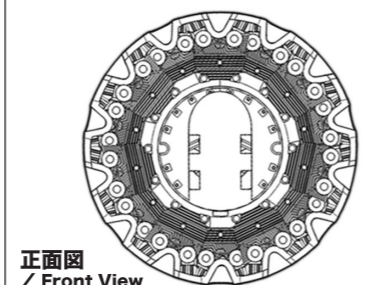

正面図 / Front View

3-1. D インテークマニホールド Intake Manifolds

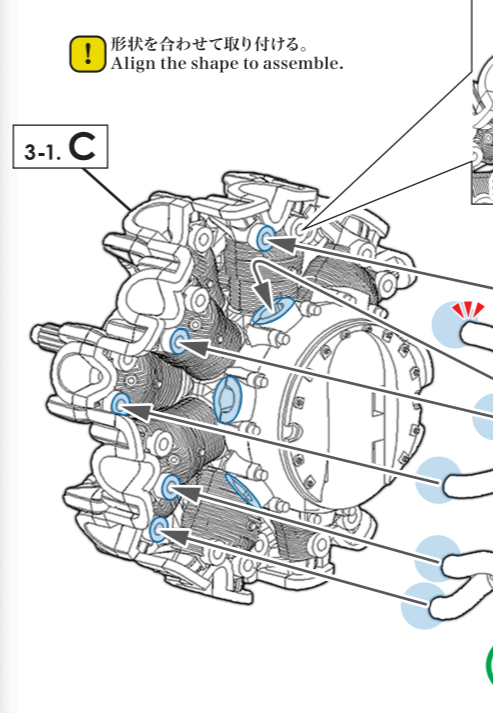

実機におけるパーツ名
Name of the parts implemented in the actual aircraft.
E-13 インテークマニホールド / Intake Manifolds

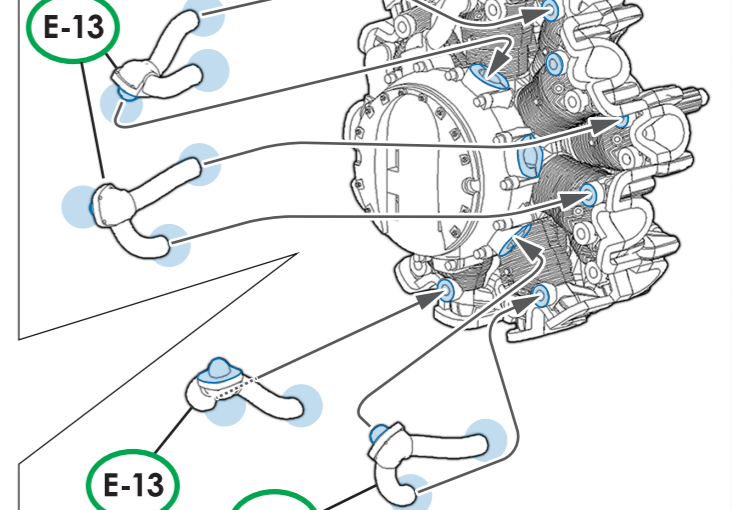

3-1. E エンジン架リング Engine Mounting Ring

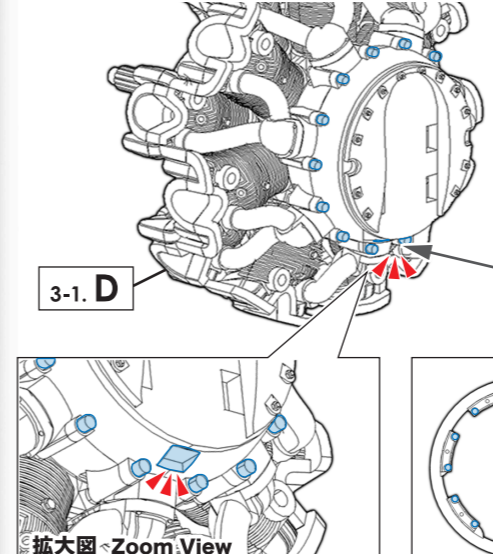

実機におけるパーツ名
Name of the parts implemented in the actual aircraft.
E-10 エンジン架リング / Engine Mounting Ring

後工程でこのパーツにエンジン架を取り付けるのでしっかりと接着する。
Be sure to cement securely because this part will be attached to the engine mount later.

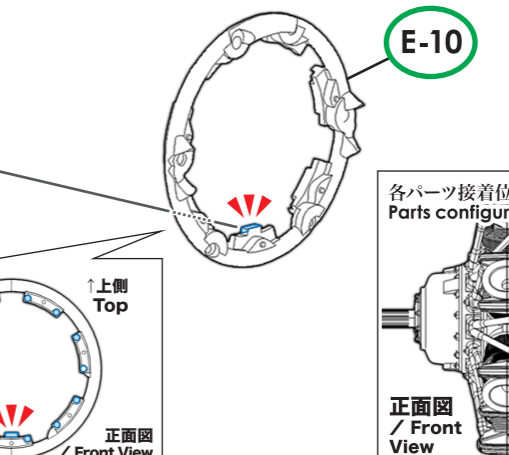

各パーツ接着位置
Parts configuration after assembly.

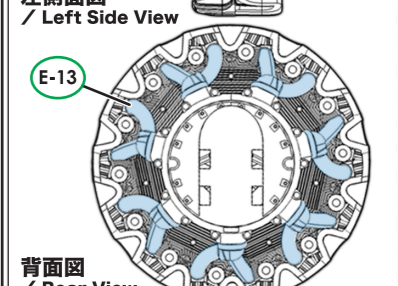

左側面図 / Left Side View

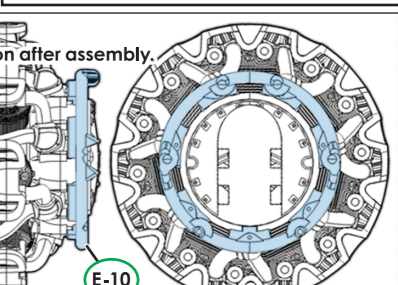

正面図 / Front View

