

### Attention!

- This item is meant for hobbyists 15 years of age or older. Please do not give this item to children under 15.
- This item is intended for use with the Zoukei-mura 1/32 "He 219 A-0 Uhu."
- The polyethylene bags that contain the parts and an assembly manual present a suffocation risk. Please do not drop the parts or bend them in unintended ways, as they may be damaged.
- In order to properly express the shape of the sculptures, it was unavoidable for some parts to have sharp edges. Please be careful.

### ZOUKEI-MURA INC. PRESENTS SUPER WING SERIES 1/32 "He 219 A-0 Uhu"

These are extra parts to be used with the "He 219 A-0 Uhu" kit.



http://www.zoukeimura.co.jp/  
http://www.master-model.pl/  
■ Plan & Design : Zoukei-Mura, Inc.  
■ Manufacturer : MASTE-MODEL  
■ Distributor : VOLKS, Inc.  
http://www.volks.co.jp/en/index.aspx  
60 Goshonouchi Nakamachi Shichi-jo,  
Shimogyo-ku, Kyoto Japan 600-8862

### SUPER WING OPTIONS

ZOUKEI-MURA INC. PRESENTS  
SUPER WING SERIES, No.6 [SWS06-M05]

### 1/32 HEINKEL He 219 A-0 Uhu

### Turned Metal Antenna Set



ZOUKEI-MURA INC. PRESENTS  
SUPER WING SERIES  
1/32 "He 219 A-0 Uhu"

These are extra parts to be used with the "He 219 A-0 Uhu" kit.

This kit is made of turned metal. Please be careful during assembly.

Plastic model cement won't work on these parts. Please use suitable instant glue.

ZOUKEI-MURA INC. All Rights reserved.

造形村 ZOUKEI-MURA INC. ¥3,000 (Including Tax ¥3,150)

### SUPER WING OPTIONS

ZOUKEI-MURA INC. PRESENTS  
SUPER WING SERIES, No.6 [SWS06-M05]

### 1/32 HEINKEL He 219 A-0 Uhu

### Turned Metal Antenna Set

Chart of Included Parts Turned Metal Antenna Set: 46 parts

Nose "FuG 220 Lichtenstein SN-2b" Antenna	Nose "FuG 212 Lichtenstein C-1" Antenna
A x 4	D x 4
B x 8	E x 8
C x 1枚	F
I x 4	J x 4
K x 4	L x 4
M	N

Pilot Tube  
Shaft Cylinder Antenna  
Ventral "FuG 25a" Antenna

### Turned Metal Antenna Set

4 518992 528397  
¥3,000 (Including Tax ¥3,150)

### Spring Unit Replacement

1/32 He 219 A-0 Uhu  
Instruction Manual p.33

### 3-6. D Attaching Main Gears

After assembling the parts I, J, K, and L (the picture shows 1 set, 4 sets to assemble), cut the red section of the spring unit (part J-22) and replace it. Do the same on the 2 struts on the left and right sides by using 2 sets for one side.

With a pin vice, make a 0.5mm hole in the cut section and affix it.

Glue/affix the parts as described in the perspective view.

Part L has an assembly orientation. Please see the perspective view, and take care when inserting the part.

Perspective View

J-22 Spring Unit

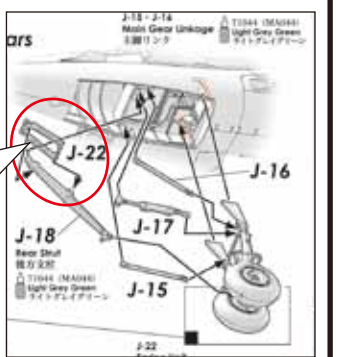

### Nose "FuG 212 Lichtenstein C-1" Antenna Replacement

1/32 He 219 A-0 Uhu  
Instruction Manual p.38

After assembling parts D and E (4 sets to assemble), cut the red section of Nose FuG 212 antenna (I-16, I-17, I-18) and replace it.

Assemble part E by inserting it into the hole of part D. Glue/affix once part E is inserted to its center.

With a pin vice, make a 0.5mm hole in the cut section and fix.

### H FuG 212レーダーアンテナ FuG212 Radar Antenna

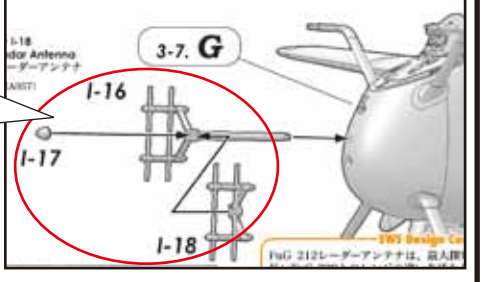

### Notices Before Assembly

Before opening the bag, please carefully read this instruction manual and verify that all the parts are included. Please also refer to the 1/32 "He 219 A-0 Uhu" instruction manual to use these parts.

To build this kit, basic tools are required (as mentioned page 6 of the He 219 instruction manual). Please make sure these tools are at hand before building the kit.

This kit allows the replacement of each nose antenna, pitot tube, and shaft cylinder part of the 1/32 "He 219 A-0 Uhu," and also reproduces the beautifully shaped and intricate silhouette of the plane. As method of replacement of each part is different, please refer to the proper instruction manual before assembling the 1/32 "He 219 A-0 Uhu."

To affix the parts of the kit, please use an instant glue. Please do not use glue dedicated to plastic models. Before painting, make a primer coat using a metal primer. (Without primer coat, paint may peel.)

The recommended brand for painting your kit is the latest line of paint from Vallejo Color, due to its non-toxicity and environmental friendliness. While referring to resources on historical Luftwaffe aircrafts, you may paint the model with the coloring of your choice.

Please carefully use the tools and the solvents used for assembly and painting by referring to their instruction manuals.

We take the utmost of care when overseeing manufacturing, but if your kit is among the very small percentage that contains a defective part, please contact customer service within two weeks of your purchase with your full name and order number.

Purchasers from VOLKS Japan International Web Site:  
Please contact imos@volks.co.jp.  
Purchasers from VOLKS USA:  
Please contact service@volksusa.com.

### 1/32 "He 219 A-0 Uhu" Assembly Instructions

These parts will be inserted when assembling the 1/32 "He 219 A-0 Uhu" kit. Please refer to the instruction manual of the "He 219 A-0 Uhu."

### Link and Actuator Replacement

1/32 He 219 A-0 Uhu  
Instruction Manual p.32

Cut the red section of the front link (part I-21) and replace it with part N.

As with part I-21, this part creates an angle.

Make a 0.5mm hole with a pin vice to insert part N.

I-21 Nose Gear Linkage

Cut the red section of the front link (part I-21) and replace it with part M.

Make a 0.5mm hole with a pin vice to insert part M.

I-22 Nose Gear Actuator

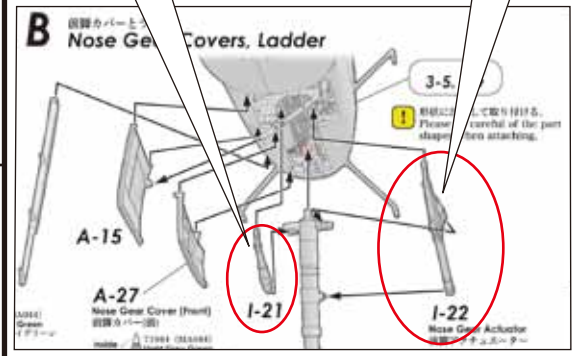

### Nose "FuG 220 Lichtenstein SN-2b" Antenna Replacement

1/32 He 219 A-0 Uhu  
Instruction Manual p.39

Assemble parts A, B, and C. Picture shows 1 set. After assembling 4 sets, replace it with part J-29. When assembling, follow the process as described in the blue box. Affix the parts so that the antennas are horizontal and vertical.

Assemble the mold.

Enlarged picture of assembly

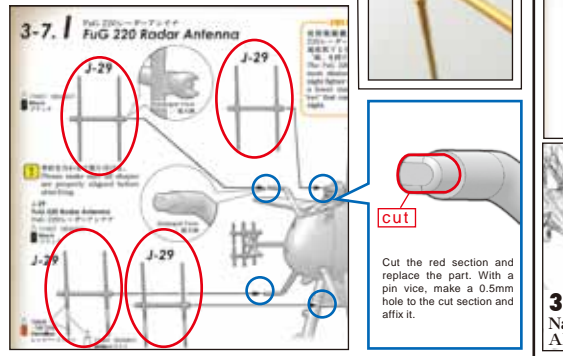

### 3-7. J Morane Antenna, etc.

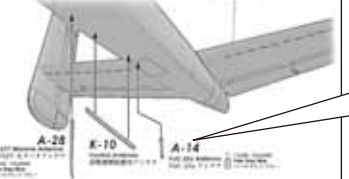

### 3-7. K Loop Antenna, Trailing Antenna

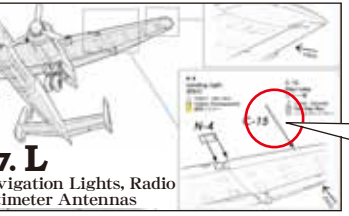
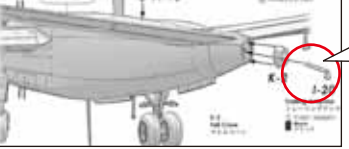

### 1/32 He 219 A-0 Uhu Instruction Manual p.39

### Ventral "FuG 25a" Antenna Replacement

Replace the part A-14 with part G of this set.

G

### Trailing Antenna Replacement

Replace the part I-20 with part H of this set.

H

Before assembling, bend the parts at the same angle. Bend carefully using your fingers.

### 1/32 He 219 A-0 Uhu Instruction Manual p.40

### Pitot Tube Replacement

Replace part C-15 with part F of this set.

F